

CCA-101: Fundamentals of IT & Programming

Assignment -1

Q1: What are the four fundamental parts of computer? Explain it with the help of diagram.

ANS:

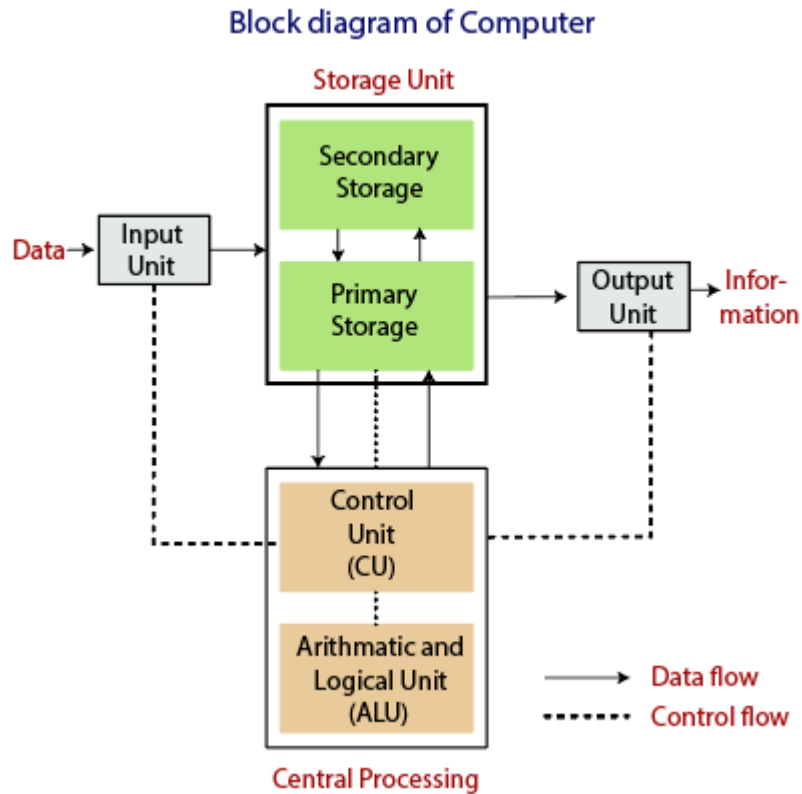

Q2: Discuss about the classification of computers based on size and capacity.

ANS : Computer can be classified into four categories based on size namely Micro, Mini, Mainframe and Super computer. Micro computers are smallest and based on the use of microprocessors. Microprocessor is combined or integrated circuit which contains all the elements of processing. ... Supercomputers are the fastest computers.

Q3: What is the meaning of computer generation? How many Computer Generations are defined? What technologies were/are used?

ANS : Generation in computer terminology is a change in technology a computer is/was being used. ... Nowadays, generation includes both hardware and software, which together make up an entire computer system. There are five computer generations known till date.

Q4: Differentiate between Volatile & Non- Volatile memories.

ANS : Volatile Memory is used to store computer programs and data that CPU needs in real time and is erased once computer is switched off. RAM and Cache memory are volatile memory. Where as Non-volatile memory is static and remains in the computer even if computer is switched off. ROM and HDD are non-volatile memory.

Q5: Distinguish among system software, application software and open source software on the basis of their features.

Ans.

Difference between System software and Application software.

Sr. No.	Key	System Software.	Application Software.
1	Definition	System Software is the type of software which is the interface between application software and system.	On other hand Application Software is the type of software which runs as per user request. It runs on the platform which is provide by system software.
2	Development Language	In general System software are developed in low level language which is more compatible with the system hardware in order to interact with.	While in case of Application software high level language is used for their development as they are developed as some specific purpose software.
3	Usage	System software is used for operating computer hardware.	On other hand Application software is used by user to perform specific task.
4	Installation	System software are installed on the computer when operating system is installed.	On other hand Application software are installed according to user's requirements.
5	User interaction	As mentioned in above points system software are specific to system hardware so less or no user interaction available in case of system software.	On other hand in application software user can interacts with it as user interface is available in this case.
6	Dependency	System software can run independently. It provides platform for running application software.	On other hand in application software can't run independently. They can't run without the presence of system software..
7	Examples	Some examples of system software's are compiler, assembler, debugger, driver, etc.	On other hand some examples of application software's are word processor, web browser, media player, etc.

What is open source software?

Open source software is software with source code that anyone can inspect, modify, and enhance.

"Source code" is the part of software that most computer users don't ever see; it's the code computer programmers can manipulate to change how a piece of software—a "program" or "application"—works. Programmers who have access to a computer program's source code can improve that program by adding features to it or fixing parts that don't always work correctly.

Q6. a) Create a file in MS-word to insert a paragraph about yourself and save it with file name

Ans.

“yourself”. Describe all steps involved in it.

Chapter 1. Creating, Opening, and Saving Documents

When you start Word without opening an existing document, the program gives you an empty one to work in. If you're eager to put words to page, then type away. Sooner or later, though, you'll want to start *another* new document. Word gives you three ways to do so:

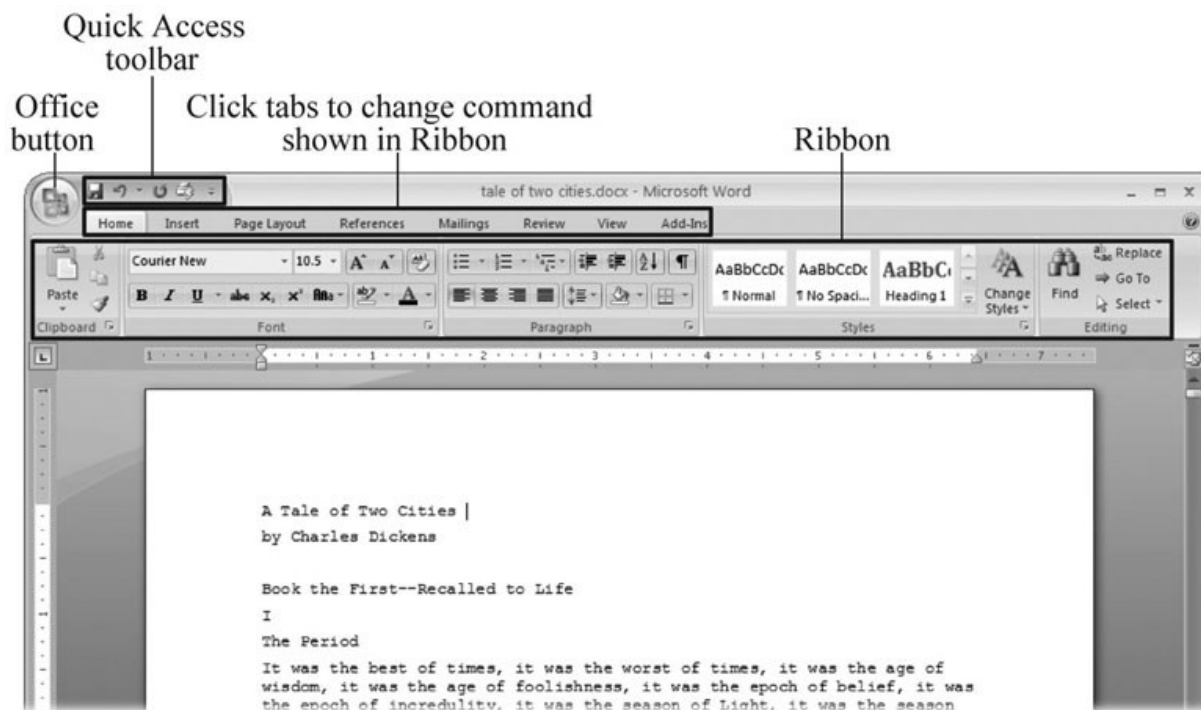

Instead of the usual Open button at the bottom of the box, the button in the New from Existing Document box reads Create New—your clue that this box behaves differently in one important respect: Instead of opening an existing file, you’re making a *copy* of an existing file. Once open, the file’s name is something like *Document2.docx* instead of the original name. This way, when you save the file, you don’t overwrite the original document. (Still, it’s best to save it with a new descriptive name right away.)

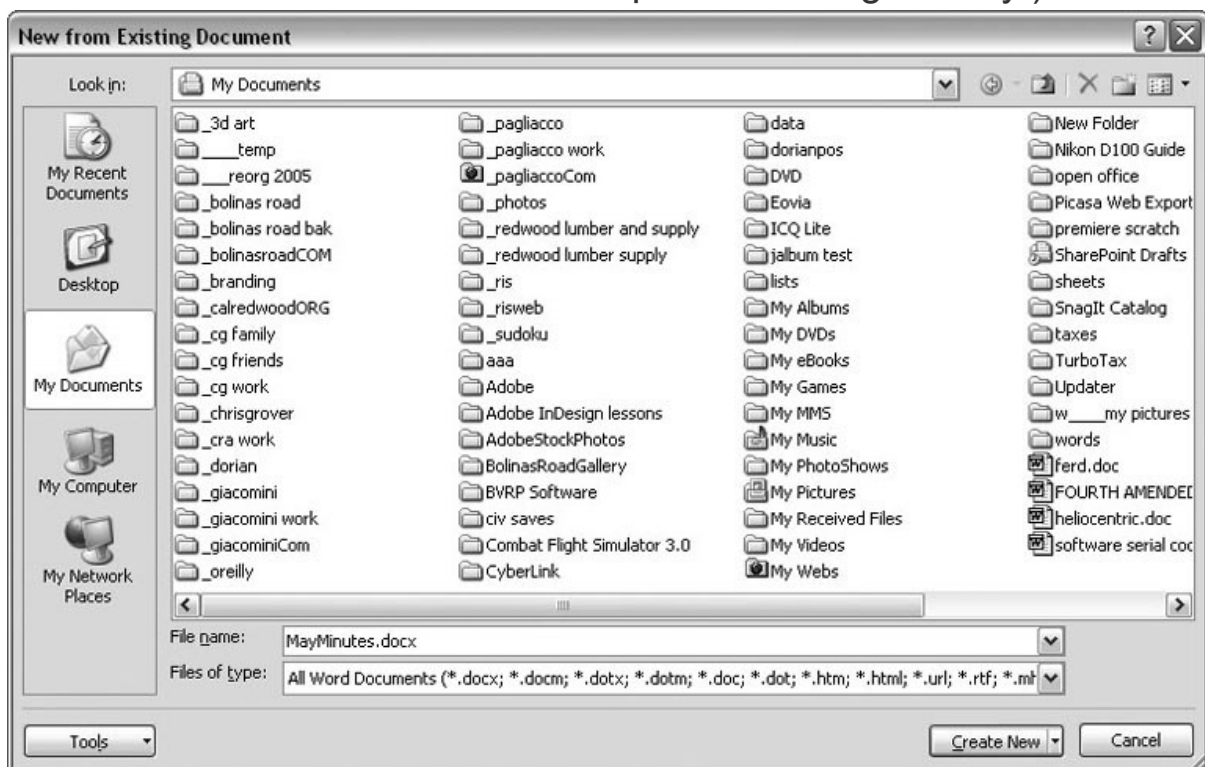

The Open box goes away and your document opens in Word. You’re all set to get to work. Just remember, when you save this document (Alt+F, S or Ctrl+S), you write over the previous file. Essentially, you create a new, improved, and only copy of the file you just opened. If you don’t want to write over the existing document, use the Save As command (Alt+F, A), and then type a new name in the File Name text box.

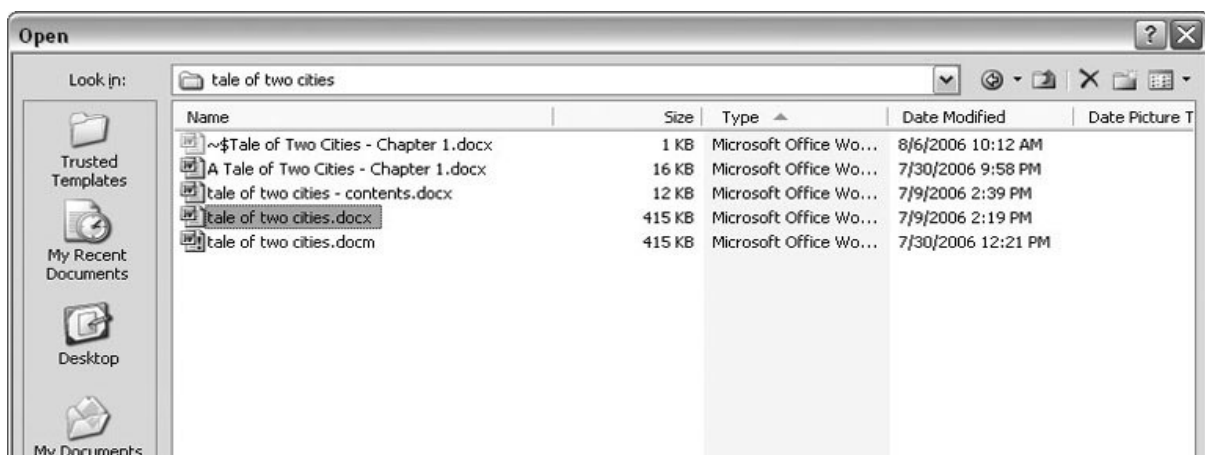

ANS : You can also place your cursor in the text and press Control+A (**Windows**) or Command+A (macOS) to select it. Use the Properties panel on the right to **change the font, style, and size.**

Change the size of selected text

To change the font size of selected text in desktop Excel, PowerPoint, or Word:

Select the text or cells with text you want to change. To select all text in a Word document, press Ctrl + A.

On the **Home** tab, click the font size in the **Font Size** box.

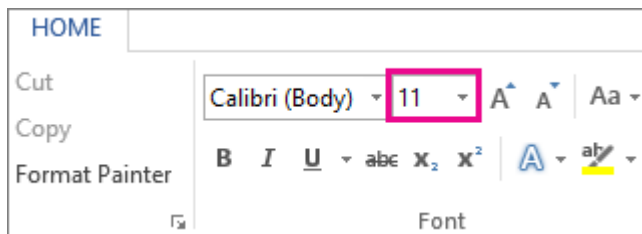

Change the font color

You can change the color of text in your Word document.

1. Select the text that you want to change.
2. On the Home tab, in the Font group, choose the arrow next to Font Color, and then select a color.



Q7. Create a file in MS-Word for the following document and save it with file name 'ms_word'. Describe all steps involved in it.

Ans.

Create a document

1. On the **File** tab, click **New**.
2. In the **Search for online templates** box, enter the type of document you want to create and press ENTER.

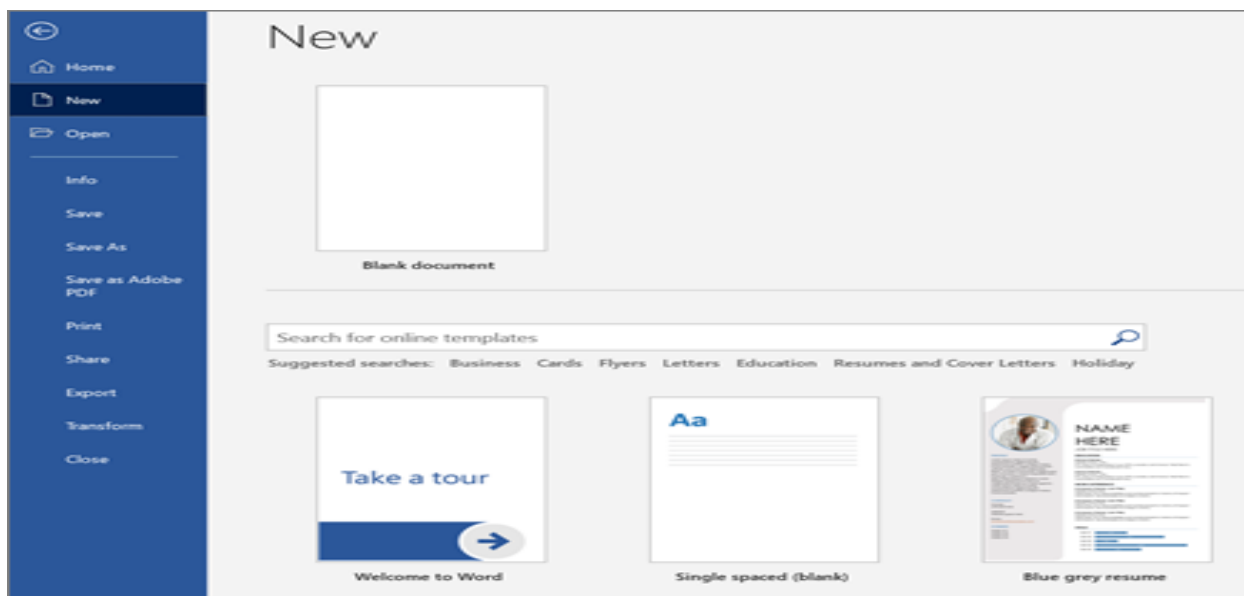

Editing

Word provides many options to customize the process of editing documents. There are several views and tools in Word that allow you to make and see changes to your document in a preferable method. The following Editing articles will also explain how to utilize the Review tab of the ribbon, which is crucial to personalizing the editing process in Word.

Q8. Create a file in MS-word for the following document and save it with file name 'equations'. Describe

all steps involved in it.

Ans.

Insert Equations in Word: Overview

This lesson shows you how to insert equations in Word within a document. This lesson covers inserting a preset equation and also manually entering an equation.

To insert equations in Word from one of the preset equations, first place your cursor at the insertion point in your document where you want the equation to appear. Then click the “Insert” tab in the Ribbon. At the right end of the tab is the “Symbols” button group. Click the drop-down arrow on the “Equation” button in this button group to then open the menu of

Q9. Create a file in MS-word that convert existing highlight text to table as shown below and save it as file name ‘text_to_table’. Describe all steps involved in it.

Ans.

Convert text to a table or a table to text

To convert text to a table or a table to text, start by clicking the Show/Hide paragraph mark on the Home tab so you can see how text is separated in your document.

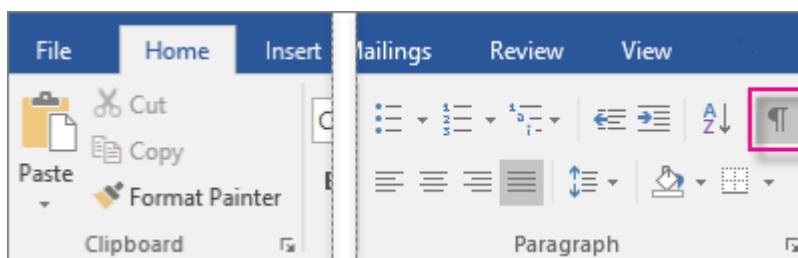

Convert text to a table

1. Insert separator characters—such as commas or tabs—to indicate where to divide the text into table columns.
 2. Use paragraph marks to indicate where you want to begin a new table row.
 3. In this example, the tabs and paragraph marks will produce a table with 3 columns and 2 rows:

Red, yellow → blue, green → orange, purple
Red, yellow → blue, green → orange, purple

Select the text that you want to convert, and then click **Insert > Table > Convert Text to Table**.

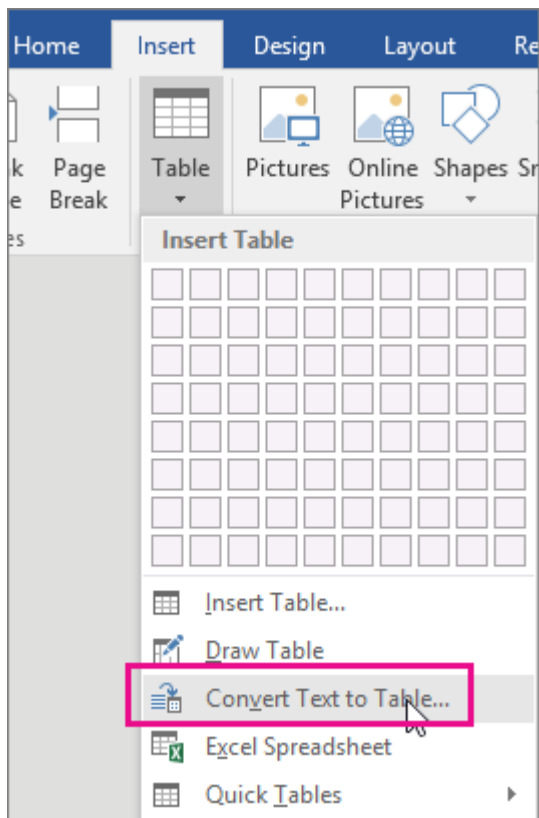

In the **Convert Text to Table** box, choose the options you want.

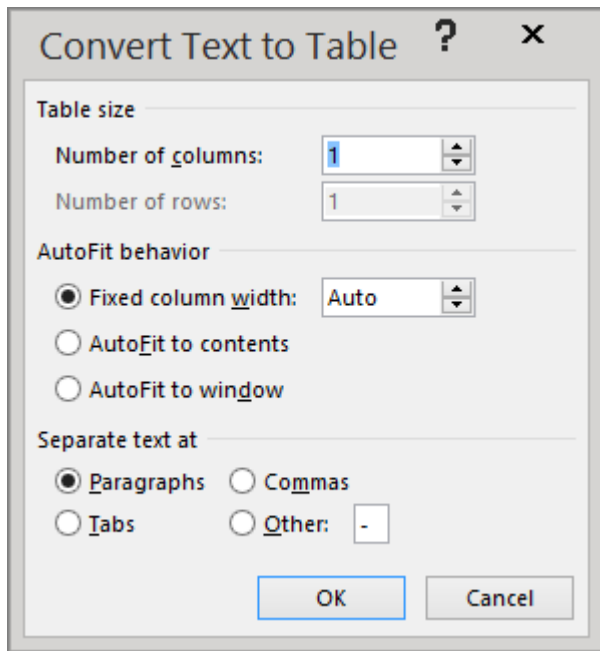

Under **Table size**, make sure the numbers match the numbers of columns and rows you want.

Under **AutoFit behavior**, choose how you want your table to look. Word automatically chooses a width for the table columns. If you want a different column width, choose one of these options:

1. Under **Separate text at**, choose the separator character you used in the text.
2. Click **OK**. The text converted to a table should look something like this:

Red, yellow	blue, green	orange, purple
Red, yellow	blue, green	orange, purple

10. Create a file in MS-Word to insert a table in the document. Describe all steps involved in it.

Ans.

he basic steps for creating a standard table in Microsoft Word (2013) are:

1. Open a blank Word document
2. In the top ribbon, press *Insert*

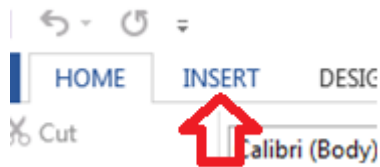

3. Click on the *Table* button

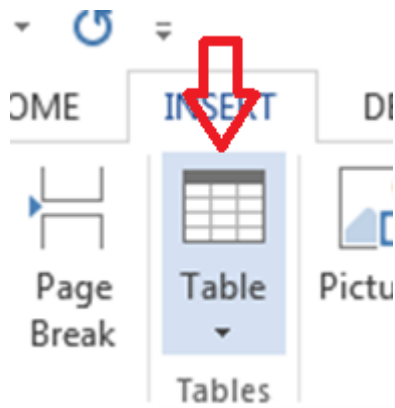

4. Either use the diagram to select the number of columns and rows you need, or click *Insert Table* and a dialog box will appear where you can specify the number of columns and rows.

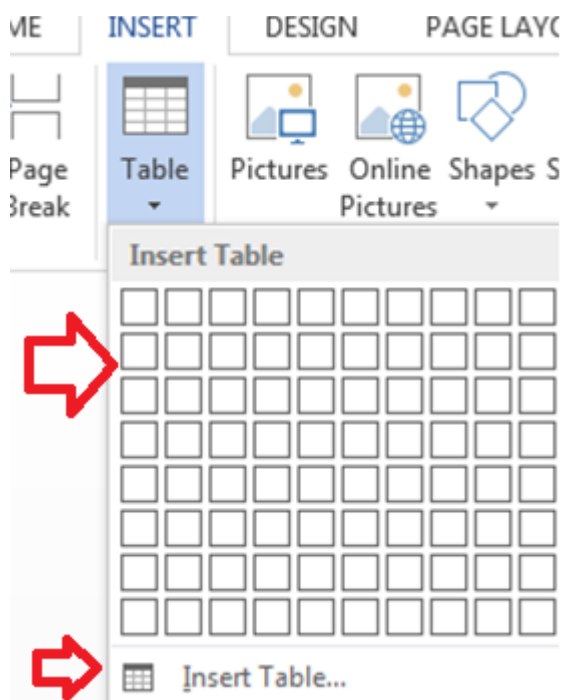

5. The blank table will now appear on the page. Alter it as necessary. Standard features like **bold**, *italics*, and underline are still available! These items may be helpful for creating headings or calling out certain items in the table.

6. Follow [these instructions](#) for ensuring your table meets APA formatting guidelines.

Need additional help? The tutoring service has self-paced table and chart lessons/tutorials within SkillSurfer. Follow these steps to access:

1. Log into the [tutoring service](#) (click on the blue hyperlink to the left to login!)

2. Click on *SkillSurfer*
3. Click on *Computers and Technology*
4. Click on *Intermediate* underneath *Microsoft Word*
5. Select *Creating Tables and Charts*
6. Choose the exact item(s) you wish to learn about (likely *Creating Tables from Scratch*).

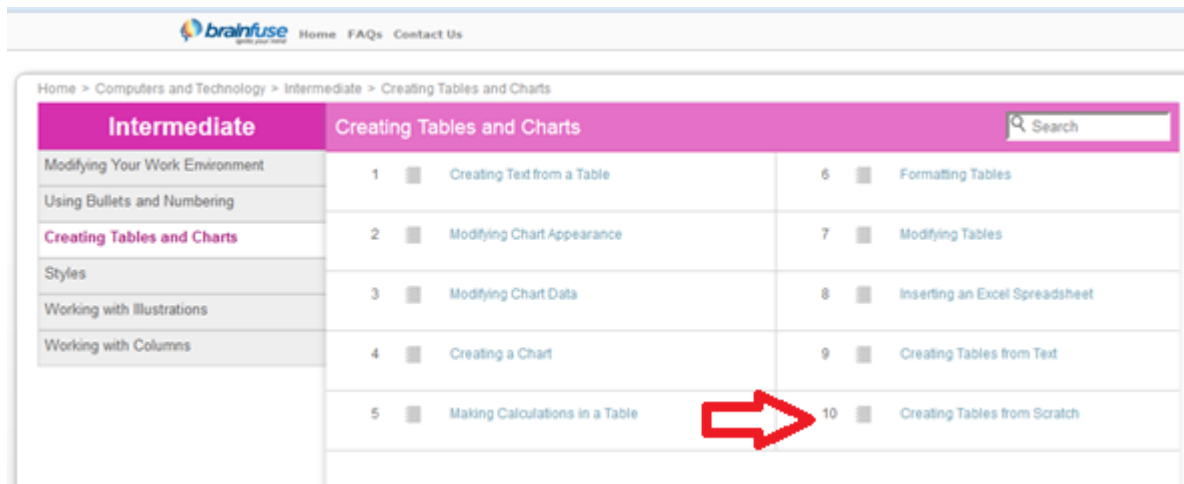

Q11. Create a following worksheet in MS-excel and save it with name 'book1'.

Ans.

Save a worksheet

When you have multiple worksheets in an Excel workbook, you might want to save only one worksheet as its own workbook. Use the Move or Copy function to save one worksheet in Excel 2013 or Excel 2016.

Save a single worksheet

1. Right-click the worksheet name tab.

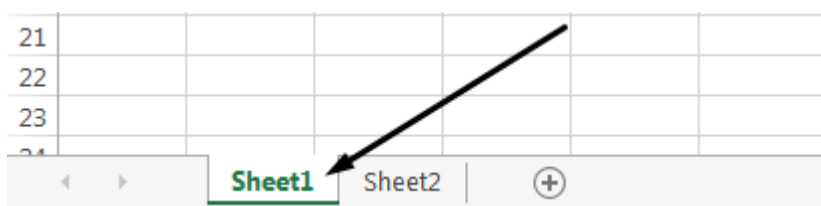

2. Click select **Move or Copy**.

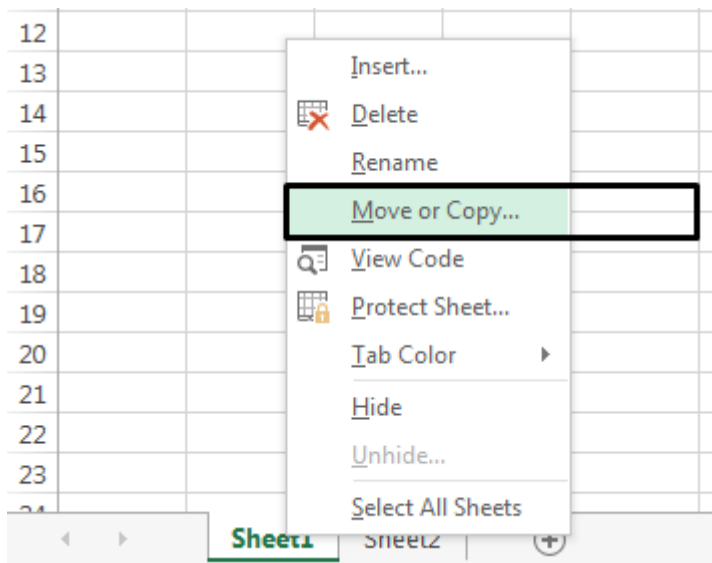

3. Click on the **Move selected sheets to Book** drop-down menu. Select **(new book)**.

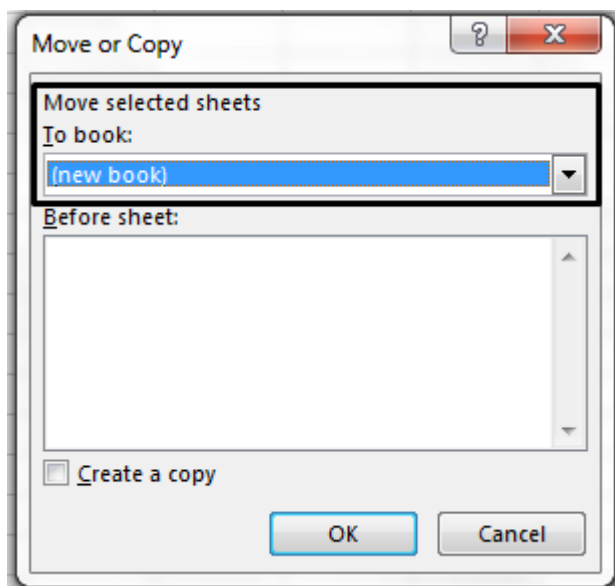

4. Click **OK**. Your new workbook opens with your moved worksheet.

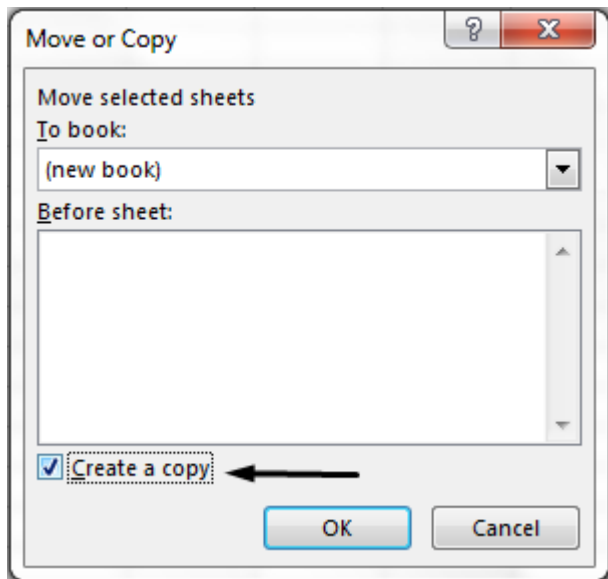

5. Click **File > Save** in your new workbook.

Q12. Calculate the following things of a range (C2:C11) of data in the worksheet created in question no

Ans.

1. the sum of the marks using AutoSum in a range of cells (C2:C11)

The SUM function adds values. You can add individual values, cell references or ranges or a mix of all three.

=SUM(A2:A10) Adds the values in cells A2:10

2. average of the marks in a range of cells (C2:C11)

Returns the average (arithmetic mean) of the arguments. For example, if the range A1:A20 contains numbers, the formula **=AVERAGE(A1:A20)** returns the average of those numbers

3. highest marks in a range of cells (C2:C11)

MAX will return the largest value in a given list of arguments. From a given set of numeric values, it will return the highest value. Unlike MAXA function,

the MAX function will count numbers but ignore empty cells, text, the logical values TRUE and FALSE, and text values.

=MAX(number1, [number2], ...)

4. minimum marks in a range of cells (C2:C11)

The Microsoft Excel MIN function returns the smallest value from the numbers provided.

=MIN(A2, A3)

Q13 a) Describe various steps involved in the following

Ans.

1.To modify column width of a worksheet

If you find yourself needing to expand or reduce Excel's row widths and column heights, there are several ways to adjust them. The table below shows the minimum, maximum and default sizes for each based on a point scale.

2.To modify the row height of a worksheet

If you find yourself needing to expand or reduce Excel's row widths and column heights, there are several ways to adjust them. The table below shows the minimum, maximum and default sizes for each based on a point scale.

3.To delete rows and columns of a worksheet

Insert or delete a column

1. Select any cell within the column, then go to **Home > Insert > Insert Sheet Columns** or **Delete Sheet Columns**.
2. Alternatively, right-click the top of the column, and then select **Insert** or **Delete**.

Insert or delete a row

1. Select any cell within the row, then go to **Home > Insert > Insert Sheet Rows** or **Delete Sheet Rows**.
2. Alternatively, right-click the row number, and then select **Insert** or **Delete**.

Q13 b) Describe following terms in the worksheet

Ans.

1.Absolute reference and relative reference in formula

Relative references

By default, all cell references are **relative references**. When copied across multiple cells, they change based on the relative position of rows and

columns. For example, if you copy the formula **=A1+B1** from row 1 to row 2, the formula will become **=A2+B2**. Relative references are especially convenient whenever you need to **repeat** the same calculation across multiple rows or columns.

2. Cell address

What is the Cell ADDRESS Function?

The cell ADDRESS function is categorized under Excel Lookup and Reference functions. It will provide a cell reference (its “address”) by taking the row number and column letter. The cell reference will be provided as a string of text. The function can return an address in a relative or absolute format and can be used to construct a cell reference inside a formula.

As a financial analyst, cell ADDRESS can be used to convert a column number to a letter, or vice versa. We can use the function to address the first cell or last cell in a range.

Formula

=ADDRESS(row_num, column_num, [abs_num], [a1], [sheet_text])

Q14. a) What tools are available to customize our PowerPoint presentation?

Ans.

Customize presentation options and views

Changing page setup options

Presentations are created mainly to project either on a projector or more and more frequently to a plasma or TV screen. There are times when a presentation can be created for delivery in different formats.

- On-screen show (4:3)
- Letter Paper (8.5 x 11 in)
- Ledger Paper (11 x 17 in)
- A3 Paper (297 x 420 mm)
- A4 Paper (210 x 297 mm)
- B4 (ISO) Paper (250 x 353 mm)
- B5 (ISO) Paper (176 x 250 mm)
- 35mm Slides
- Overhead
- Banner
- On-screen Show (16:9)
- On-screen Show (16:10)
- Widescreen
- Custom

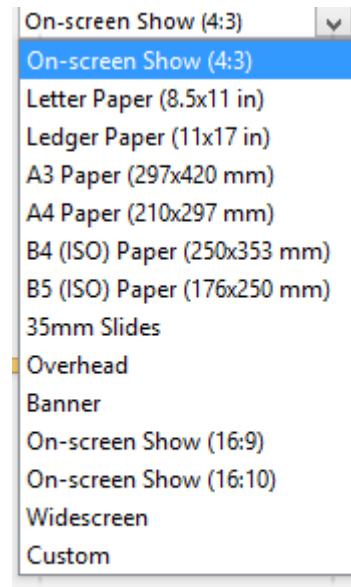

Slide Sizes

To select a slide size other than the standard one:

1. In Slide Master View
2. Click on Slide Size
3. Select from one of the two options
4. For more choices, click Custom
5. Select one of the options

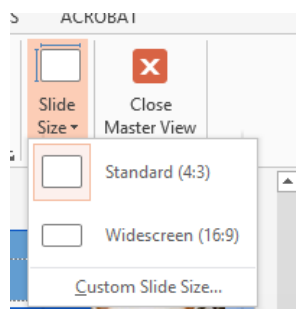

Slide Size

Figure 89- standard or widescreen

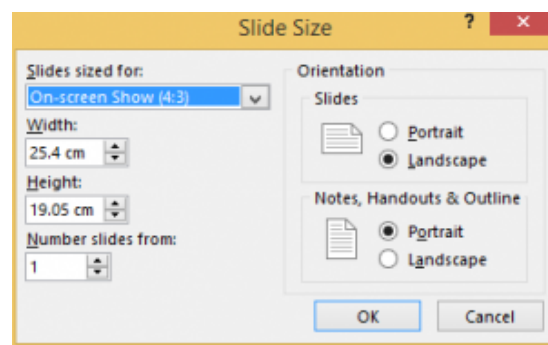

Slide Size box

Figure 90 – other options

If you change the orientation to Portrait for the presentation it will apply to all the

slides.

Changing to view in color/grayscale

Why change to view the presentation in grayscale? You might want to print the presentation and to print in colour is more expensive than printing to greyscale, so you need to see what the presentation looks like in grayscale before you print.

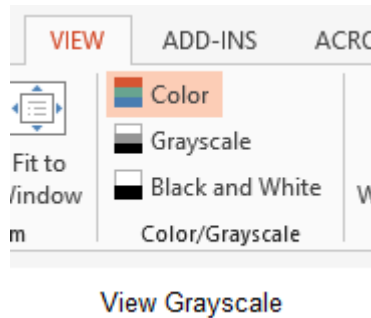

Figure 91- colour/grayscale options

On the View Ribbon, click on the option you want, Colour, Grayscale or Black and White.

Then from the Grayscale Ribbon select the option you want to see:

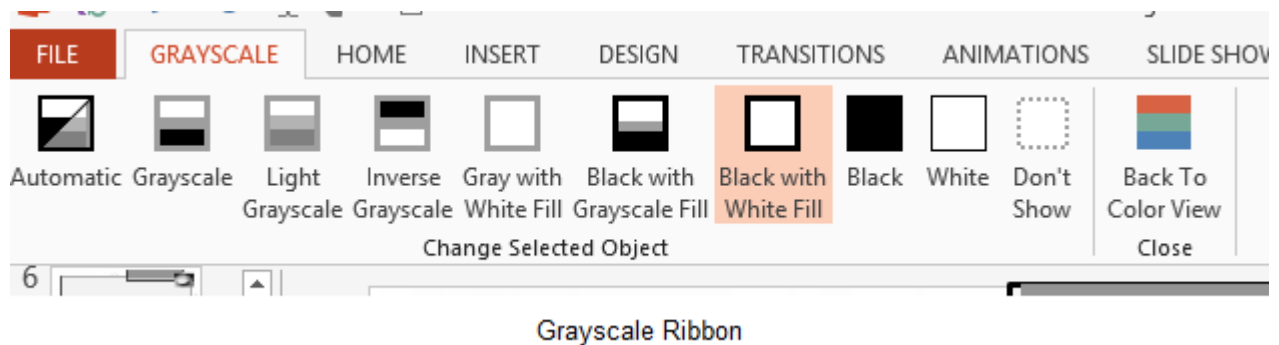

Figure 92- grayscale options

To get back to the colour view, click Back to Colour View.

Navigating using presentation views

There are several different views in PowerPoint as we saw earlier and you can navigate through the presentation in each in different ways.

In Normal View

- Click on the thumbnail of the slide you want to see
- Use the Vertical Scrollbar to move between slides
- Use the up and down arrow keys on the keyboard to move one slide backwards or forwards

In Slide Sorter View

- Click on the slide you want to select
- Use the arrow keys to move up, down, left and right

In Reading View

Use the next and back icons in the status bar to move back or forwards or use the menu which is accessed from the icon in the middle

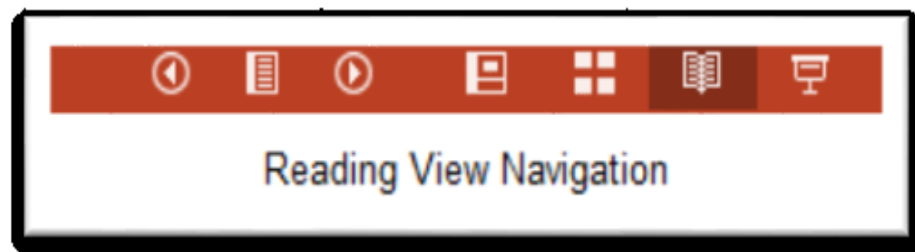
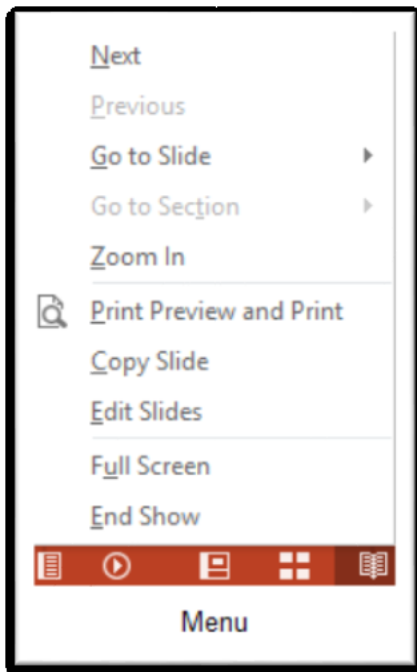

Figure 94 – icons

Back and Next icons move between slides.

Figure 93- reading view

Pick from the menu – you can use Go to Slide to pick the slide number

In Slide Show view

When presenting you can use the mouse or the arrows on the keyboard to move through the presentation one slide at a time.

You can also type the number of the slide you want to see and press Enter.

When you hover the mouse over the bottom left corner of the slide on display you will notice some faint icons, there is a back arrow and forward arrow which move you through one slide at a time.



Slide show icons

Figure 95- slide show icons

Use the fourth icon along to show the slides in a presentation view of Slide Sorter View. This lays the slides on the screen and you can click on the one you want to see



Slide Sorter In Presentation View

Figure 96- Slide Sorter in presentation view

Use the back arrow at the top left to get back to the slide you started from.

To end the slide show, press the Escape Key on the keyboard – this takes you back to PowerPoint in the edit mode which means that your audience will see the back end of your presentation.

You can also use the End Presentation option which is on the small ellipse icon on the bottom left of the slide when you hover the mouse.

Q14 b) Write the steps for the following action for creation of power point presentation

Ans.

1. Open a Blank presentation

To create a new presentation:

When beginning a new project in PowerPoint, you'll often want to start with a new blank presentation.

1. Select the **File** tab to go to **Backstage view**.

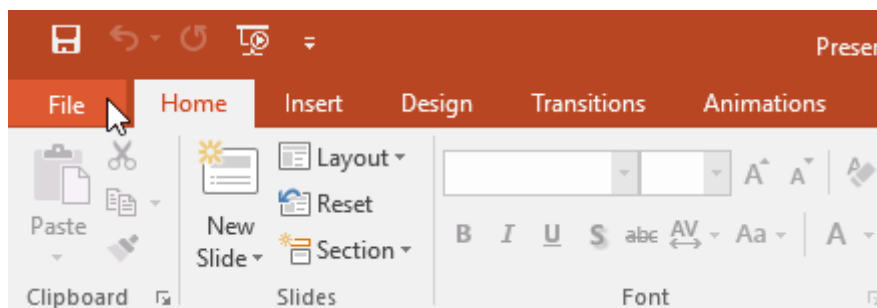

2. Select **New** on the left side of the window, then click **Blank Presentation**.

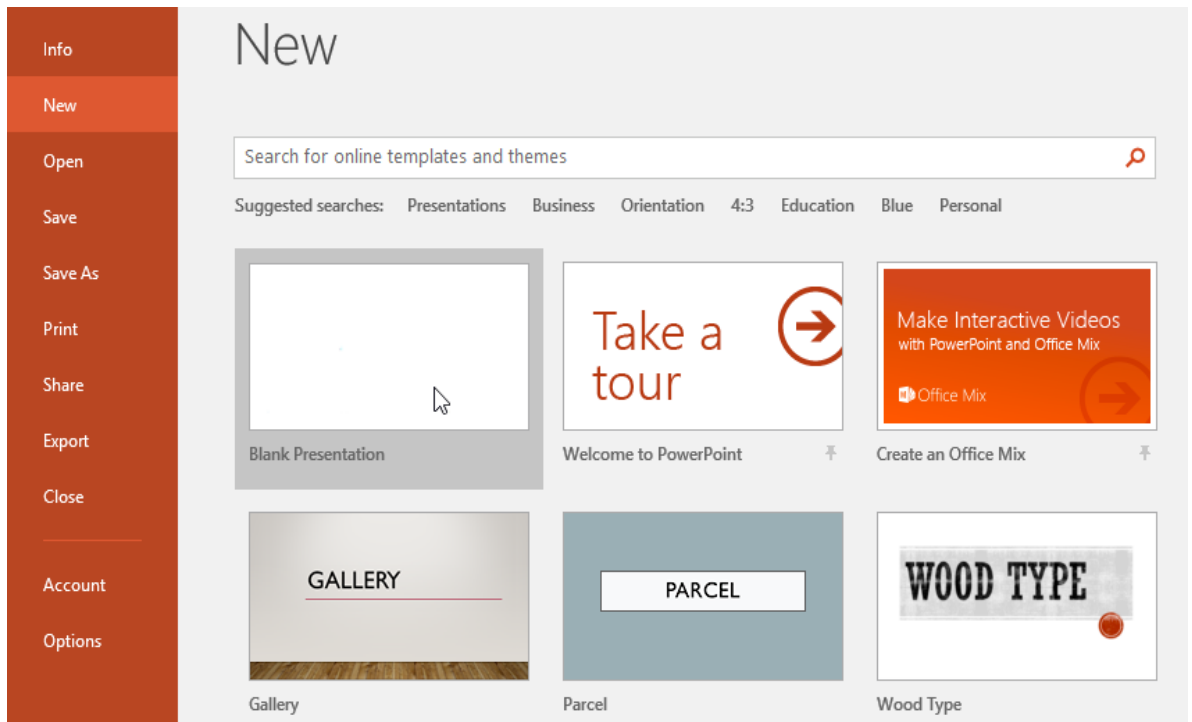

3. A new presentation will appear.

To create a new presentation from a template:

A **template** is a **predesigned presentation** you can use to create a new slide show quickly. Templates often include **custom formatting** and **designs**, so they can save you a lot of time and effort when starting a new project.

1. Click the **File** tab to access **Backstage view**, then select **New**.
2. You can click a suggested search to find templates or use the **search bar** to find something more specific. In our example, we'll search for the keyword **chalkboard**.

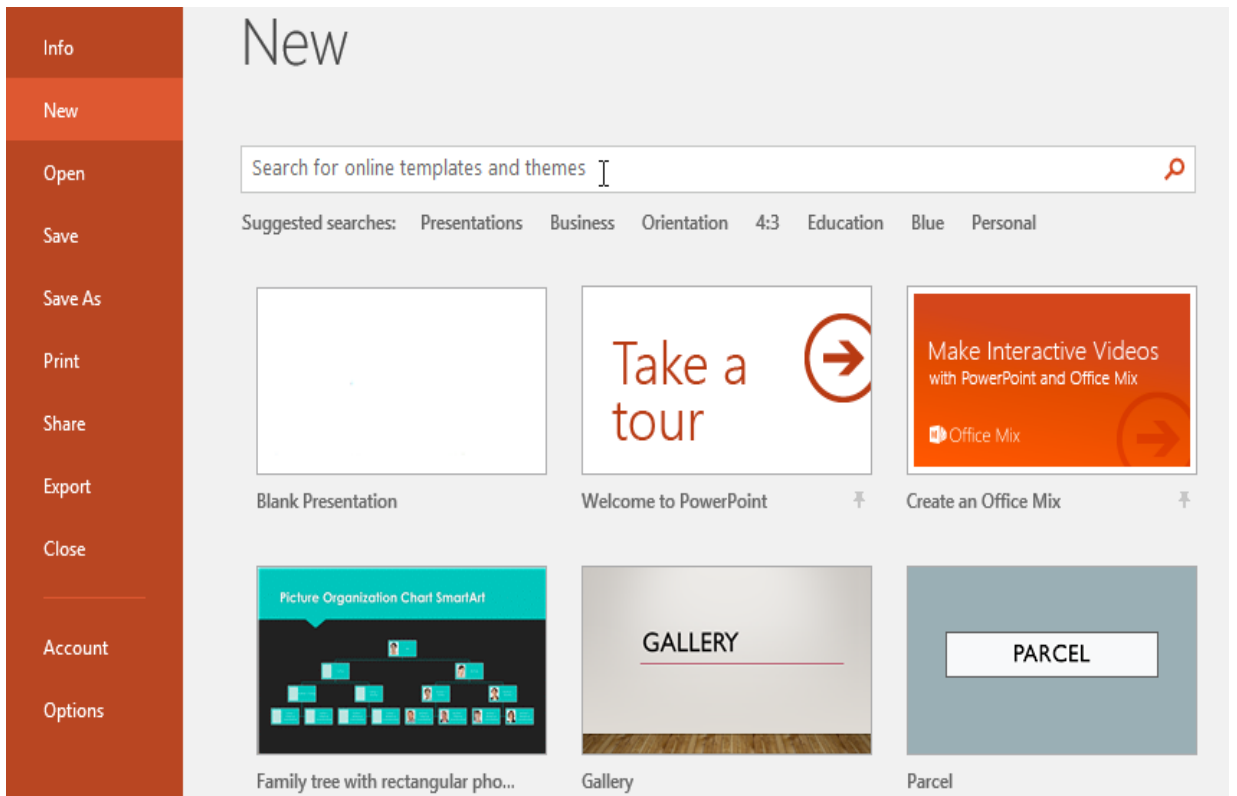

3. Select a **template** to review it.

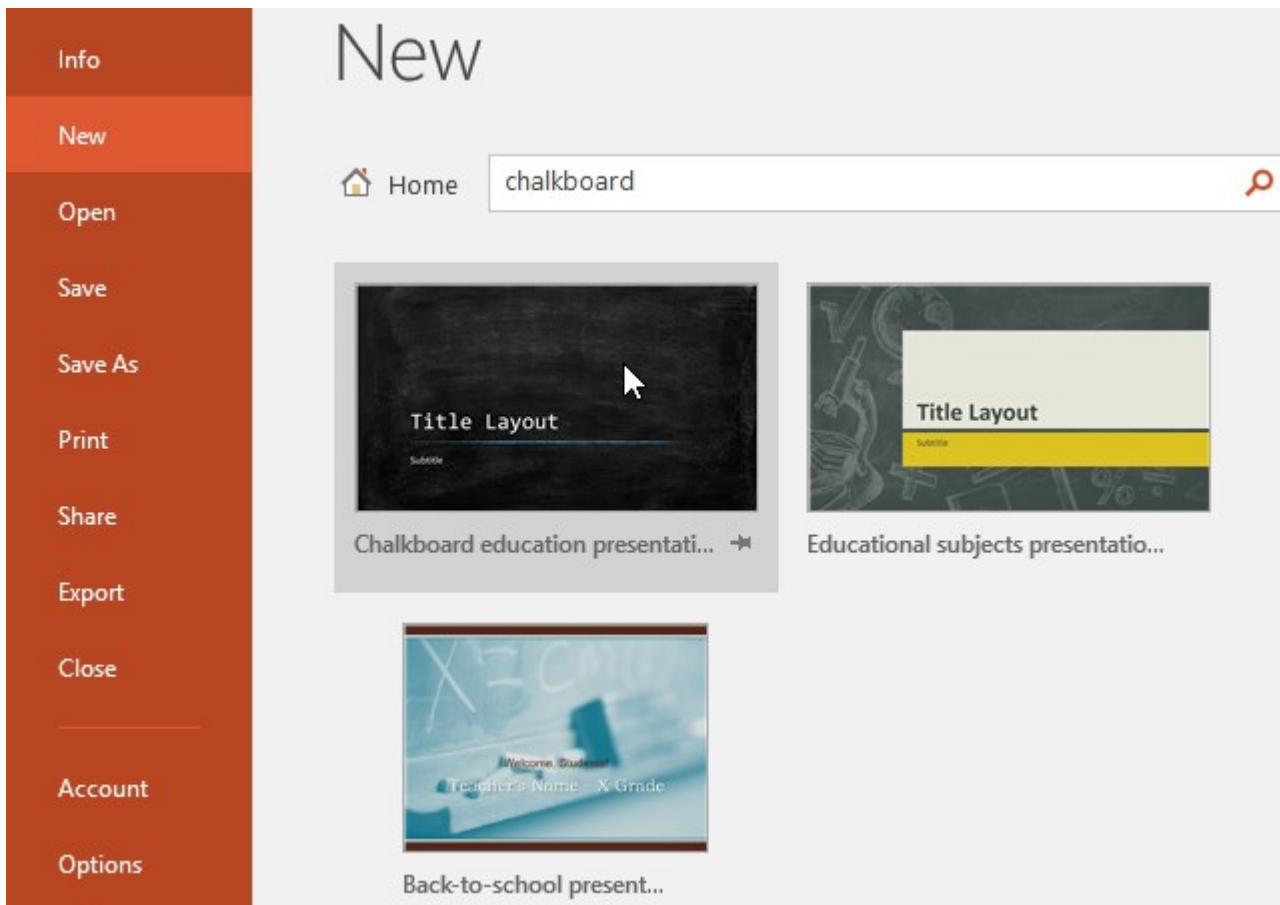

1. A **preview** of the template will appear, along with **additional information** on how the template can be used.
2. Click **Create** to use the selected template.

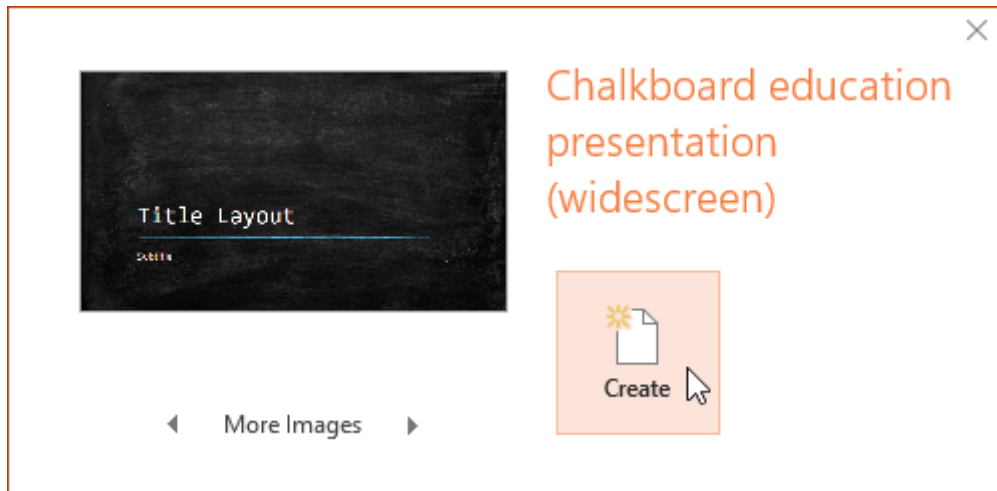

3. A new presentation will appear with the **selected template**.

It's important to note that not all templates are created by Microsoft. Many are created by third-party providers and even individual users, so some templates may work better than others.

To open an existing presentation:

In addition to creating new presentations, you'll often need to open a presentation that was previously saved. To learn more about saving presentations, visit our lesson on [Saving Presentations](#).

1. Select the **File** tab to go to **Backstage view**, then click **Open**.

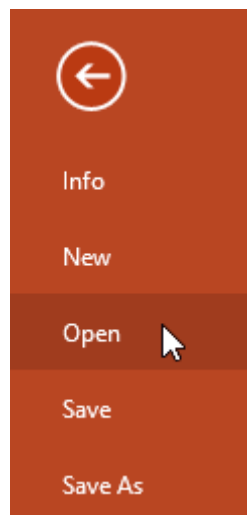

2. Click **Browse**. Alternatively, you can choose **OneDrive** to open files stored on your OneDrive.

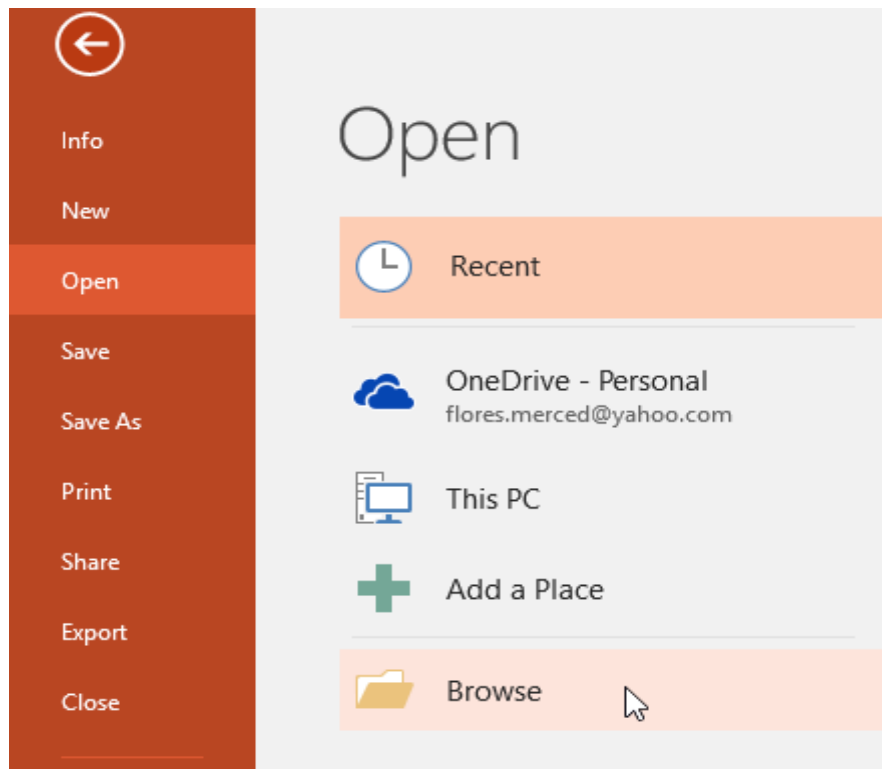

3. The **Open** dialog box will appear. Locate and select your **presentation**, then click **Open**.

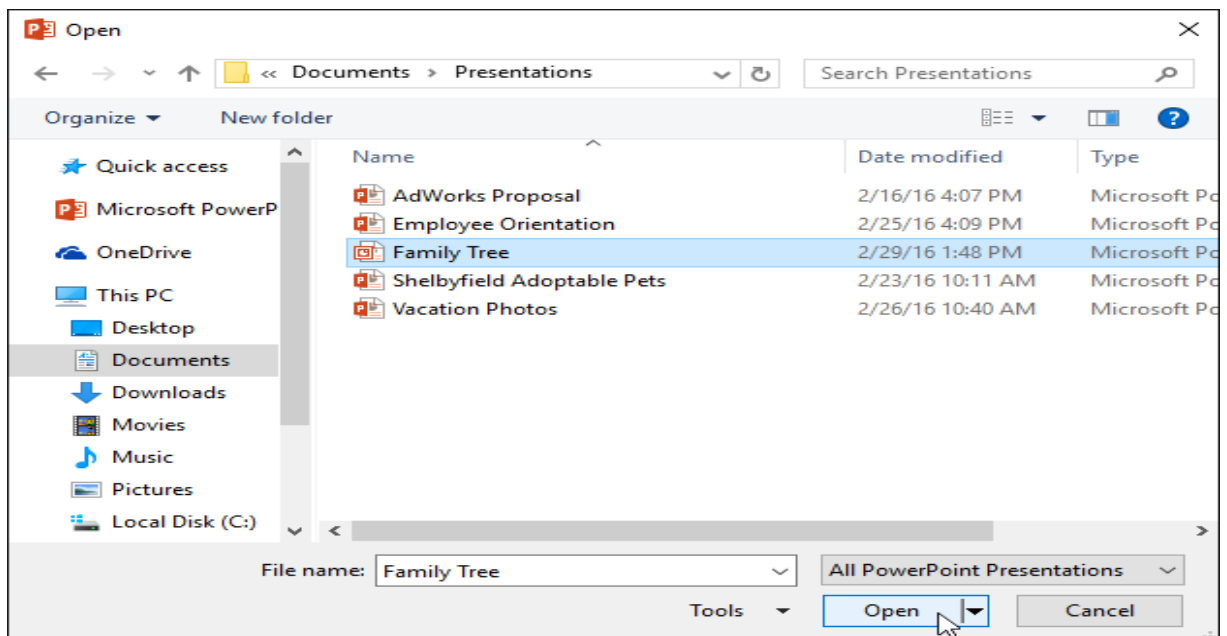

2. Save the presentation as Lab1.pptx

Ans.

- One of the most basic tasks in PowerPoint is being able to save your work; this is probably the most important task as well. There are many users who have burnt their fingers for not saving their work in time and losing hours of hard work. The following are the basic steps to save a presentation.
- **Step 1** – Click on the **File** tab to launch the **Backstage** view and select **Save**.

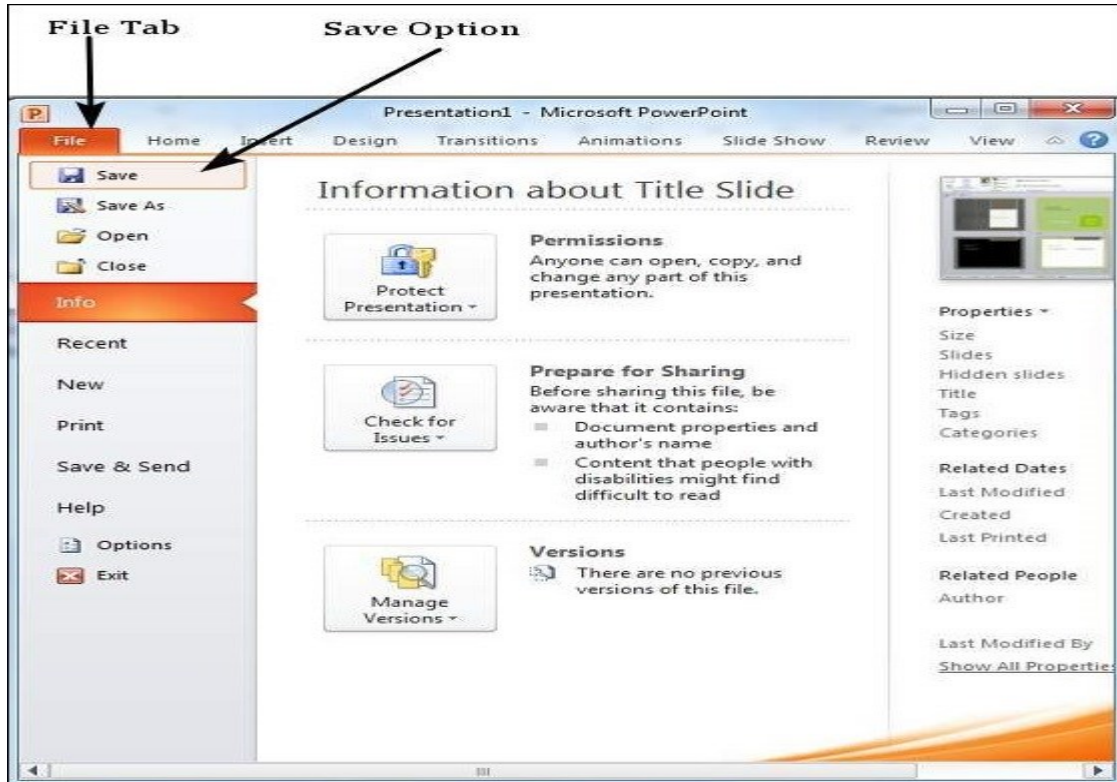

Step 2 – In the **Save As** dialog, type in the file name and click "Save"

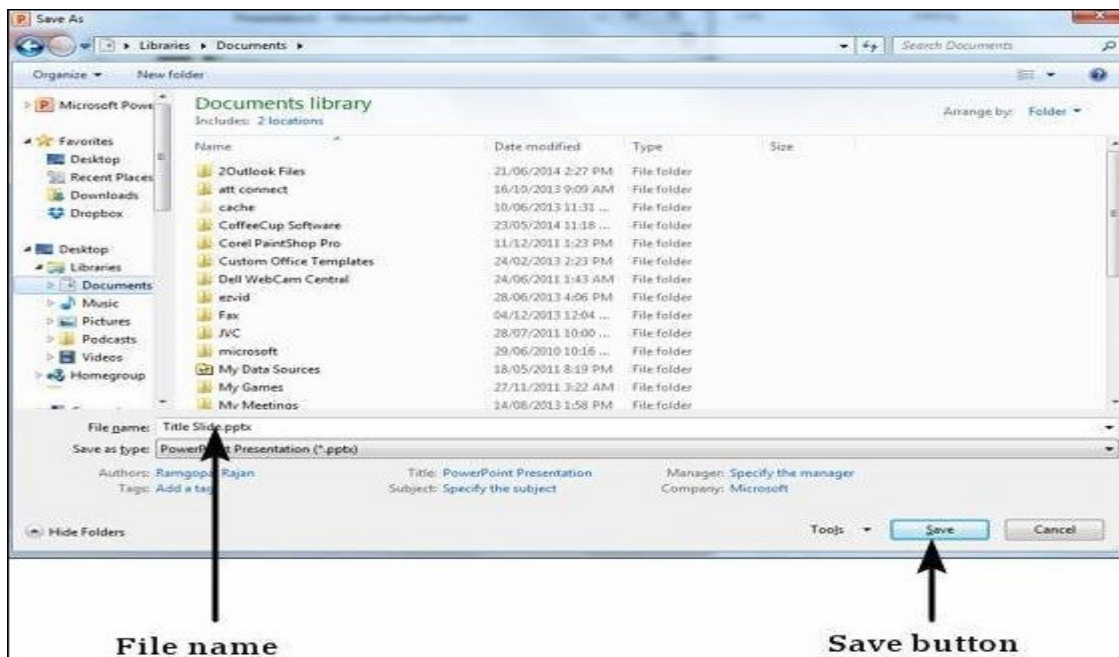

Step 3 – The default file format is **.pptx**. If you want to save the file with a different name, choose one of the file types from the **"Save as type"** dropdown list.

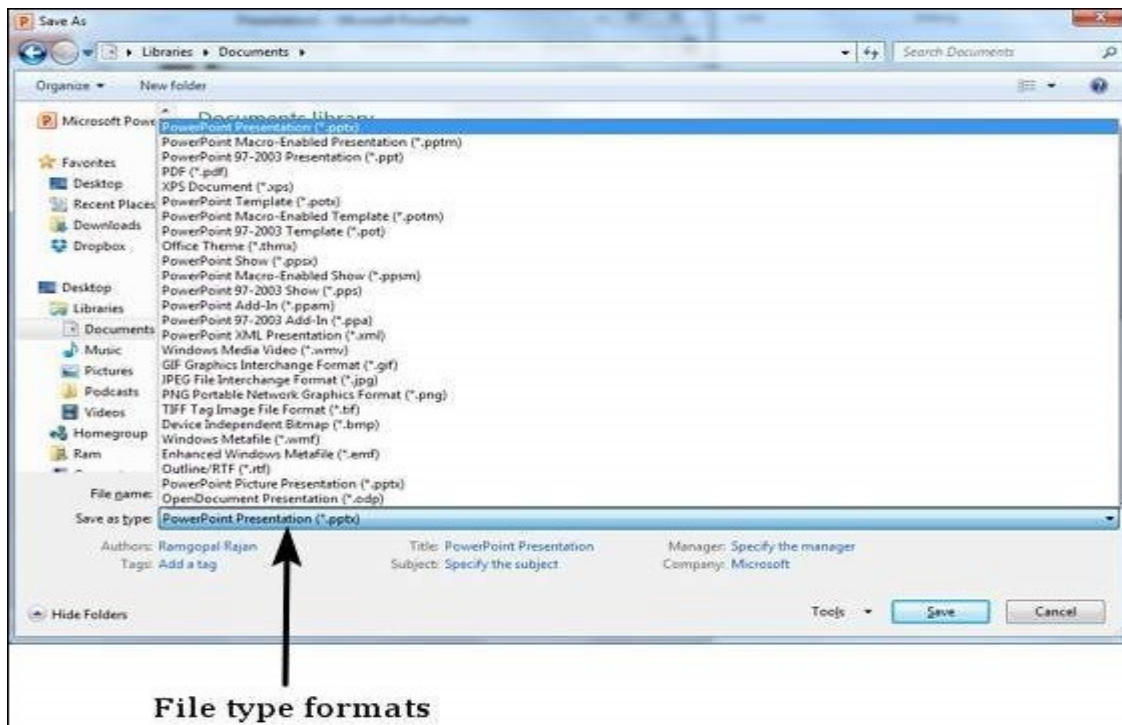

If you are working on an already saved file, the **"Save"** option in the **Backstage** view will directly save the file in the existing format with the existing name. If you want to change the format or filename of an existing file, use the **Save As** option instead.

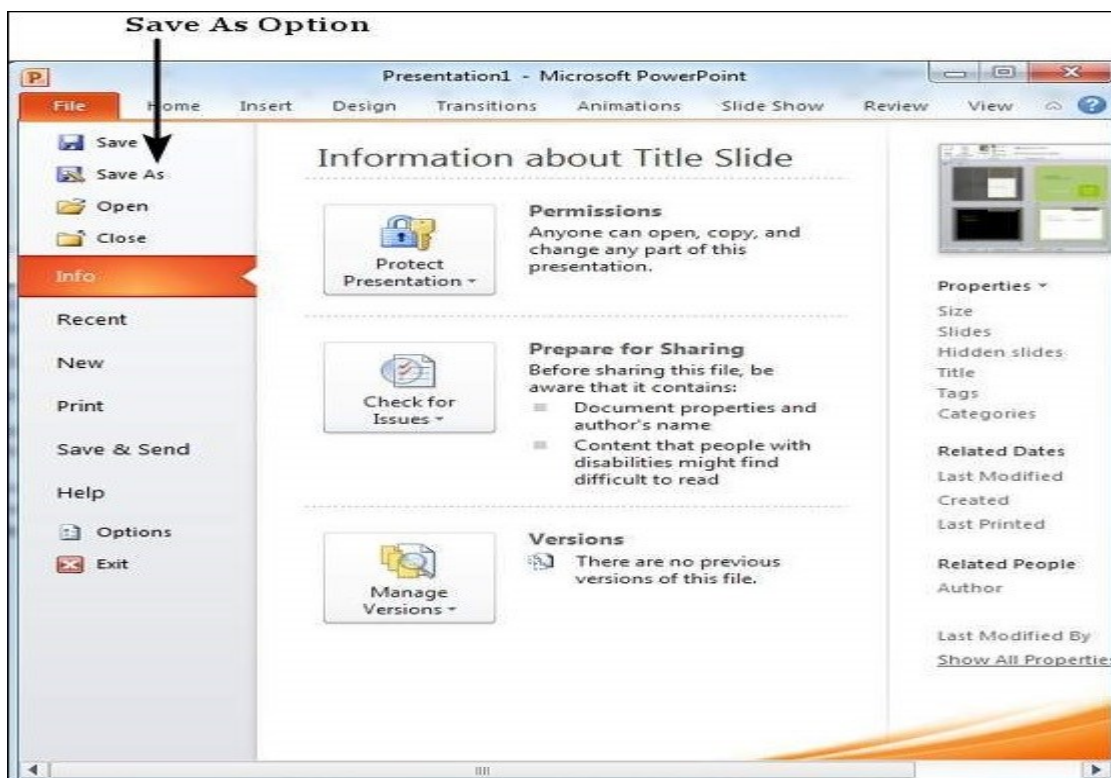

3. Add a Title to the first slide: the name of your college

Ans.

1. Open a **Blank presentation**
2. Save the presentation as **PowerPointLabOne.pptx**
3. Add a **Title** to the first slide: **the name of your college**
4. Type your first name and last name in the **Subtitle** section
5. Add a **New Slide** which has a **Title and Content**
6. Add a title to the second slide "**My Future Goals**"
7. In the Content section of the second slide, add at least three Personal Goals
8. Right click on the second slide from the left panel, then choose **Duplicate Slide**
9. Highlight the text in the Content area of the third slide. Under the Home tab, click **Convert to SmartArt**, then choose **Basic Cycle**
10. Change the SmartArt Colors to **Colorful—Accent Colors**
11. Change the SmartArt Styles to **3D Polished**
12. From the left panel, **drag** the third slide between the first and second slide
13. Change the **layout** of the third slide, the slide that does not have the SmartArt, to **Comparison**
14. Leave the title "**My Future Goals**"
15. In the head of the first column, type "**Goals in College,**" then center the heading
16. In the head of the second column, type "**Goals after College,**" then center the heading
17. Add at least **three goals** in each section
18. Make sure that **slide #3** is selected from the left panel, then add a **New Slide**
19. Change the layout of the new slide to **Blank**
20. Insert a Graduation **Online Picture** from the **Office ClipArt**—Choose any image of your choice
21. Change the ClipArt **size to 3" X 3"** and position it in the middle of the slide
22. Apply the **Wisp Design Theme**
23. Save and upload **PowerPointLabOne.pptx** to your instructor

5. Add a New Slide which has a Title and Content

Ans. Insert a New Slide in PowerPoint: Overview

In this tutorial, you will learn how to insert a new slide in PowerPoint. When you create a new presentation, PowerPoint gives you one default slide that contains a "Title

Slide” layout. You can click into the placeholders shown in the title slide. Then type the text you want to appear as the title and subtitle of your presentation.

To add another presentation slide, you must then insert a new slide and determine which placeholders appear in it. The slide layout you apply determines which placeholders appear within the new slide. However, you can also change the slide layout to change the placeholders after it is applied.

To insert a new slide in PowerPoint with a “Title and Content” slide layout, click the “Home” tab in the Ribbon. Then click the “New Slide” button in the “Slides” button group.

To insert a new slide in PowerPoint with a different slide layout, click the drop-down

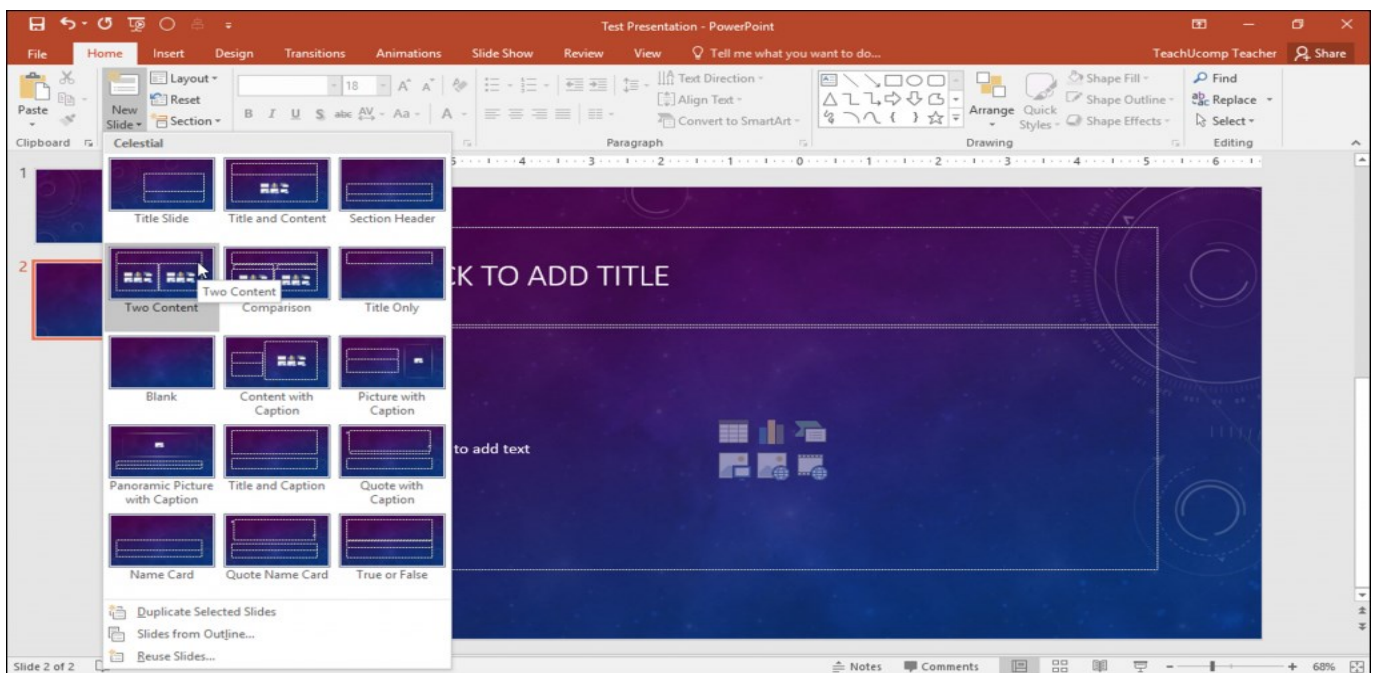

Q15. Write steps for creation of a set of PowerPoint slides that demonstrates your skill to use the tools of PowerPoint. It should include the following things

A) Title slide & bullet list

Ans.

Title a slide

There are multiple way to add titles to your slides in PowerPoint. Use the Layout option to create a standalone title slide or to add a title to a slide that contains other text. You can also use the Outline view to create and update the titles of your slides

Show each bullet point with a click

1. Select the text box that contains the slides you want to animate.



2. Click the **Animations** tab, and then choose a motion effect like **Appear** or **Fly In**.



3. The slide displays the animation sequence in a box to the left of each point.



Show each bullet point after a delay

1. Select all the bullet points you want to animate, click the **Animations** tab, and then choose a motion effect like **Appear** or **Dissolve In**.

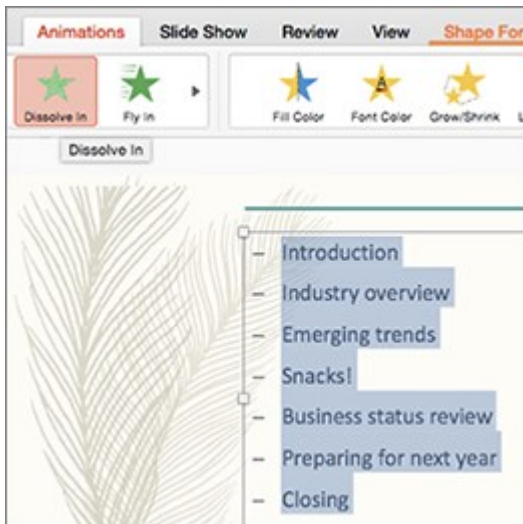

2. In the **Animations** pane, select the *second* animation in the list.

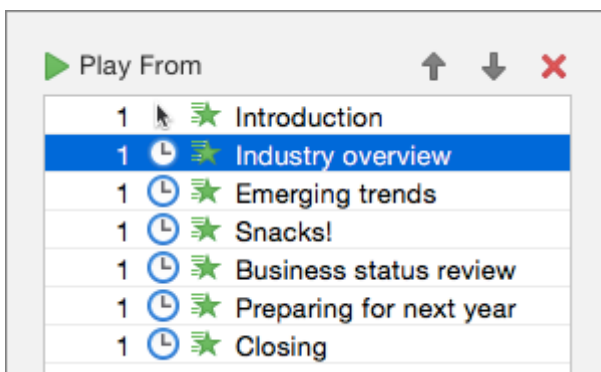

3. Under **Timing**, change the **Start** setting to **After Previous**, and then enter the amount of time you want to delay between each bullet point.

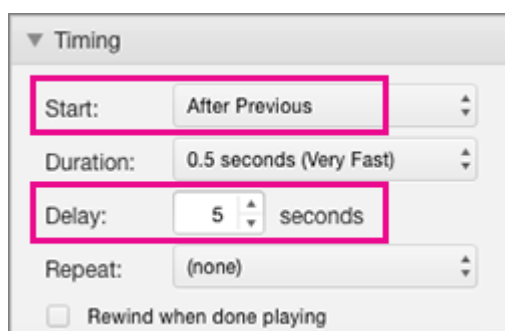

B) Inserting Excel Sheet

Ans. Insert an object in your Excel spreadsheet

You can use Object Linking and Embedding (OLE) to include content from other programs, such as Word or Excel.

OLE is supported by many different programs, and OLE is used to make content that is created in one program available in another program. For example, you can insert an Office Word document in an Office Excel workbook. To see what types of content that you can insert, click **Object** in the **Text** group on the **Insert** tab. Only programs that are installed on your computer and that support OLE objects appear in the **Object type** box.

Embed an object in a worksheet

1. Click inside the cell of the spreadsheet where you want to insert the object.

2. On the **Insert** tab, in the **Text** group, click **Object**  .

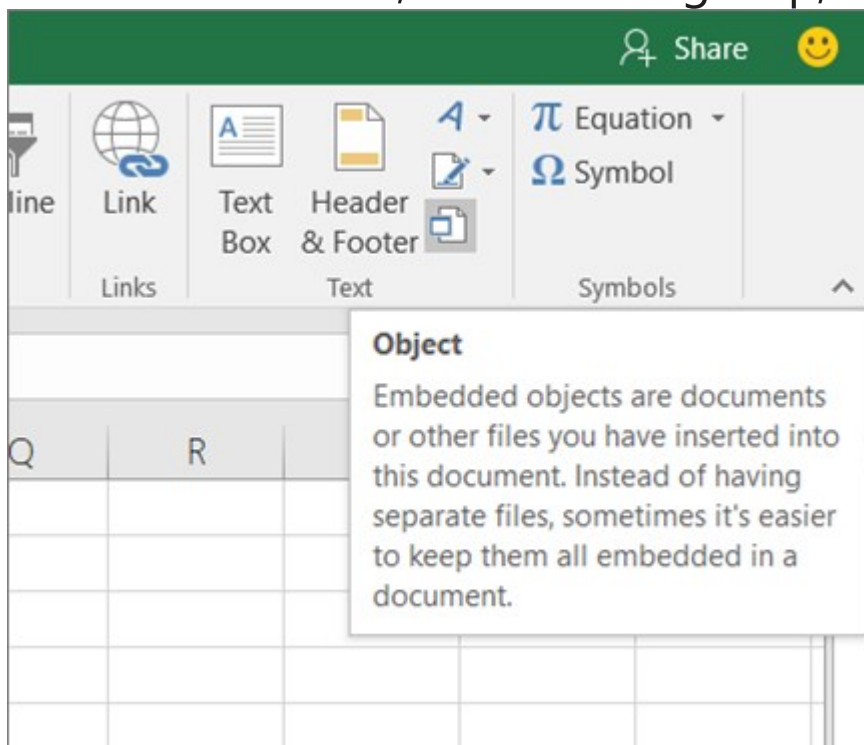

3. In the **Object** dialog box, click the **Create from File** tab.
4. Click **Browse**, and select the file you want to insert.
5. If you want to insert an icon into the spreadsheet instead of show the contents of the file, select the **Display as icon** check box. If you don't select any check boxes, Excel shows the first page of the file. In both cases, the complete file opens with a double click. Click **OK**.

Insert a link to a file

You might want to just add a link to the object rather than fully embedding it. You can do that if your

workbook and the object you want to add are both stored on a SharePoint site, a shared network drive, or a similar location, and if the location of the files will remain the same. This is handy if the linked object undergoes changes because the link always opens the most up-to-date document.

1. Click inside the cell of the spreadsheet where you want to insert the object.
2. On the **Insert** tab, in the **Text** group, click **Object**  .

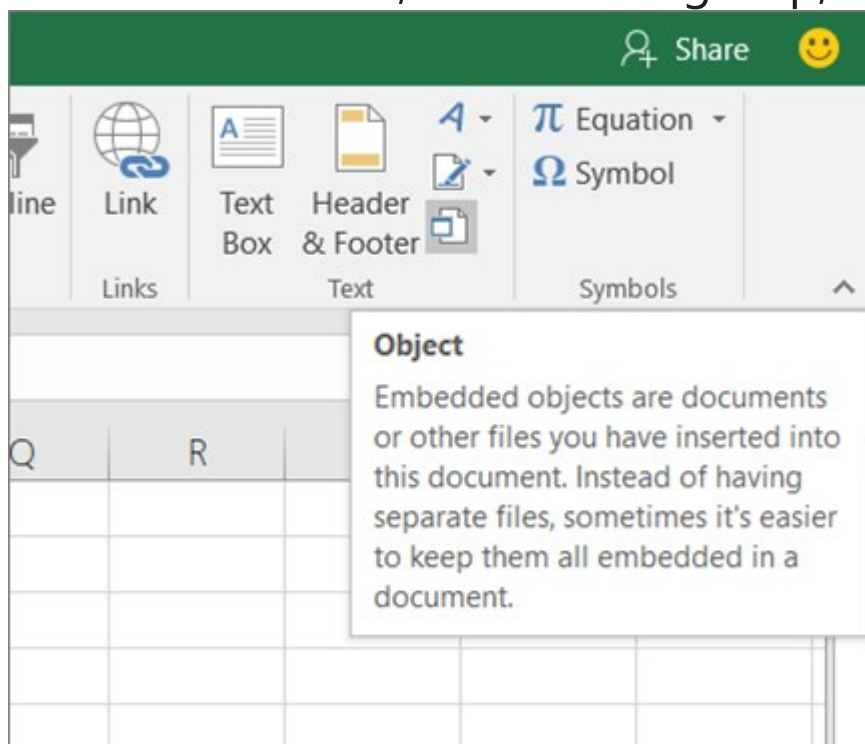

3. Click the **Create from File** tab.
4. Click **Browse**, and then select the file you want to link.
5. Select the **Link to file** check box, and click **OK**.

Create a new object from inside Excel

You can create an entirely new object based on another program without leaving your workbook. For example, if you want to add a more detailed explanation to your chart or table, you can create an embedded document, such as a Word or PowerPoint file, in Excel. You can either set your object to be displayed right in a worksheet or add an icon that opens the file.

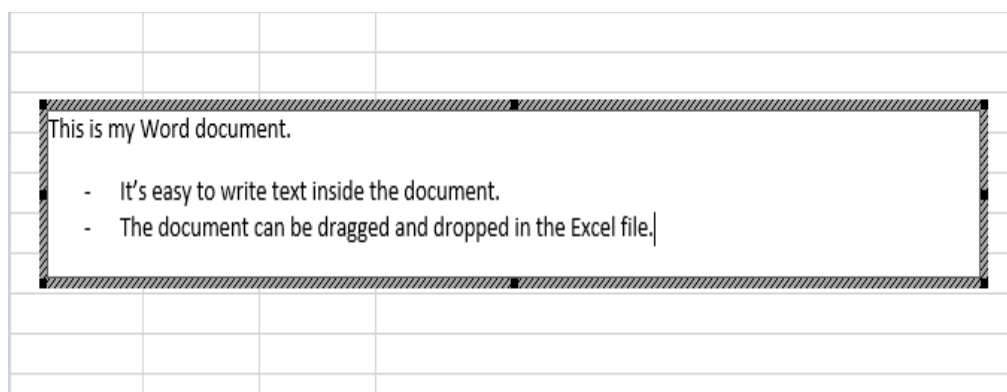

1. Click inside the cell of the spreadsheet where you want to insert the object.

2. On the **Insert** tab, in the **Text** group, click **Object**  .

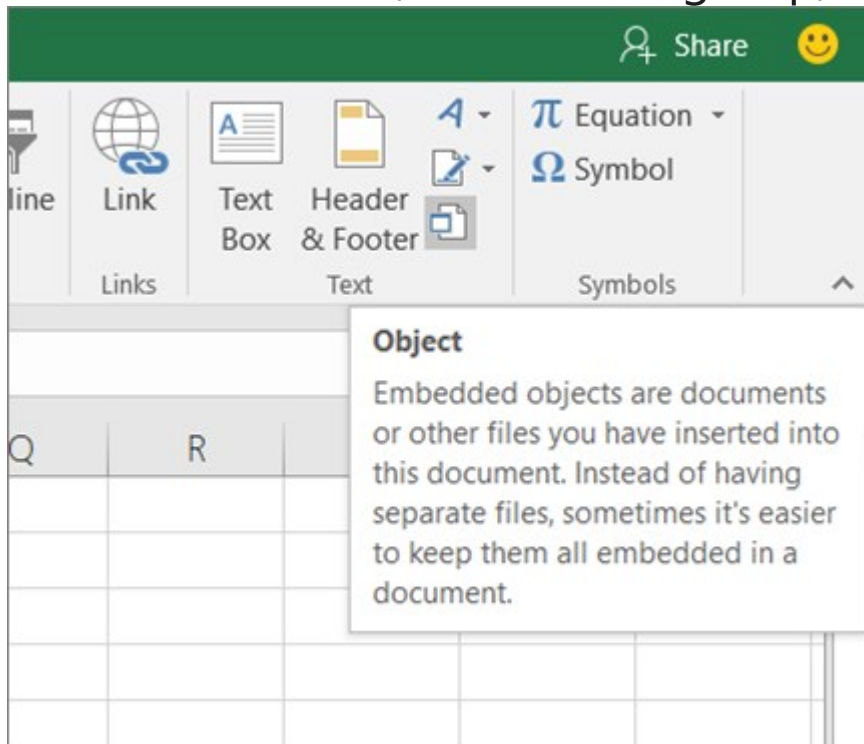

3. On the **Create New** tab, select the type of object you want to insert from the list presented. If you want to insert an icon into the spreadsheet instead of the object itself, select the **Display as icon** check box.
4. Click **OK**. Depending on the type of file you are inserting, either a new program window opens or an editing window appears within Excel.
5. Create the new object you want to insert.

When you're done, if Excel opened a new program window in which you created the object, you can work directly within it.

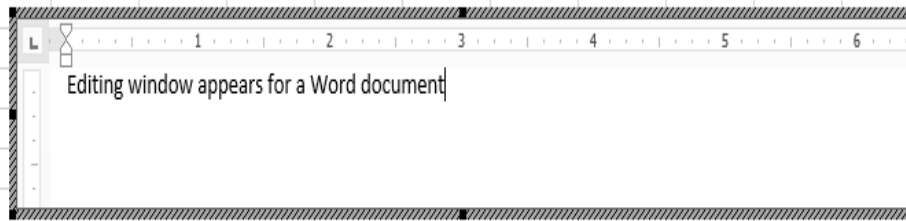

When you're done with your work in the window, you can do other tasks without saving the embedded object. When you close the workbook your new objects will be saved automatically.

C) Clip art and Text

Ans. Clip art (also **clipart**, **clip-art**), in the graphic arts, is pre-made images used to illustrate any medium. Today, clip art is used extensively. Clip art comes in many forms, both electronic and printed. However, most clip art today is created, distributed, and used in an electronic form. Since its inception, clip art has evolved to include a wide variety of content, file formats, illustration styles, and licensing restrictions. Clip art is generally composed exclusively of illustrations (created by hand or by computer software), and does not include

Text

the main body of matter in a manuscript, book, newspaper, etc., as distinguished from notes, appendixes, headings, illustrations, etc.

the original words of an author or speaker, as opposed to a translation, paraphrase, commentary, or the like: the actual wording of anything written or printed:

D) Slide show effects

Ans. Slide Effect is a presentation tool providing enhanced transitions and effects. Using a standard Presentation Software user interface, people can create slide presentation with movies and images in a simpler way than using a video editing software.